

PARTS, ASSEMBLY AND SAFETY MANUAL

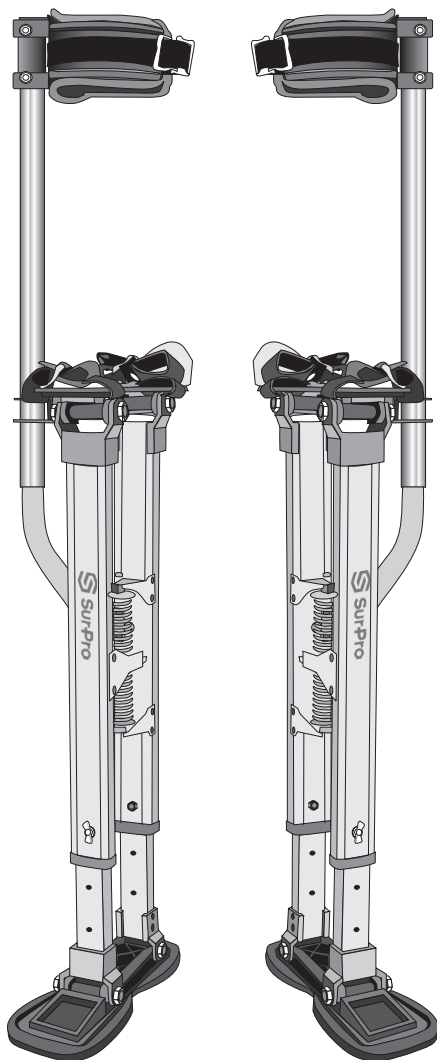

SINGLE SIDED SUR-STILTS



PLEASE READ CAREFULLY BEFORE ASSEMBLY OR USE

TABLE OF CONTENTS

About	3
Warnings and Safety Precautions	4
Stilt Components and Assembly	
Your Box Includes	5
Heel Bracket Installation	5
Arch & Toe Strap Positions	6, 7
Toe Strap Installation	7
Single Sided Pole Installation	8
Stilt Adjustments	
Stilt Height	9
Side Pole Rotation	10
Spring Tension	10
Learning to Walk	
Walking Instructions	11
Walking Safety Tips	11
Maintenance Instructions	
Cleaning	12
Lubrication	12
Replacement Parts	12
Replacement Parts Diagram	13
Replacement Parts & Kits	14, 15
Warranty	
Sur-Pro One-Year Limited Warranty	16
Sur-Pro Product Registration	16
Warranty Service	16

ABOUT

Sur-Pro stilts are designed and manufactured for the use in the commercial drywall and construction industry. Sur-Pro stilts **are NOT** designed for recreational use or use as a performance prop.

Proper assembly, inspection, and maintenance are required every time before use. New users need to learn safe and proper walking techniques before using the stilts at a jobsite. (See **Learning to Walk** pg. 11)

Read the manual and the following safety guidelines thoroughly. Understand that The Forest Group, Inc. is not responsible for any incidences resulting from negligence, unintended use of the stilts, failure due to lack of maintenance or improper assessment of equipment.

WARNING: Sur-Pro stilts have a load limit of **225 lbs.**
DO NOT EXCEED!



QUESTIONS? NEED HELP?

If you have any comments or questions regarding your stilts, please contact our customer service department.



Toll Free : 1-888-443-8889



WARNINGS & SAFETY PRECAUTIONS

- **Under no circumstances** should the stilts be used while under the influence of alcohol, drugs, or other medications that could impair your balance, judgment, or cause drowsiness.
- **Always** perform a jobsite inspection to be sure it is free of any tripping hazards including, but not limited to: extension cords, spilled liquids, or general debris. Your worksite **should not** have any open stairwells, vents, or windows that would present a fall or tripping hazard.
- **Always** inspect your stilts prior to every use. Check for worn or damaged parts and always replace with genuine Sur-Pro parts. Check and tighten all nuts and bolts, but do not over-tighten any loose nuts, wing bolts, or screws. The Forest Group, Inc. is not responsible for any equipment failures if non-genuine Sur-Pro parts are used.
- Clean your stilts regularly. Dirty equipment may obscure excessive wear. Keep soles and ground clean, dry and free of lubricants, debris or obstacles which may cause slipping or tripping. **Never** use your stilts on scaffolding or plywood placed over any type of opening. Only use on solid ground.
- Keep all pivot points and adjustment joints clean and lubricated. Lubricate lightly, when necessary, with silicone or graphite-based lubricants.
- Mount and dismount your stilts with the help of a spotter using a clear and level area away from doors, windows, stairwells, floor vents, etc. **Never jump off** a stilt. Step down using a work platform of the appropriate height.

STILT COMPONENTS & ASSEMBLY

YOUR BOX INCLUDES

	Qty	Description	Part #
Box	1	Left main stilt body	-
	1	Right main stilt body	-
	1	Left upper strut for side poles with leg band	H105-XXXX
	1	Right upper strut for side poles with leg band	H105-XXXX
	2	Lower struts for side poles	H123-XXXX
Inner Bag	2	Side pole clamps	HP12930
	2	Wraparound leg band straps	H101PF
	2	Heel cups with nuts and screws attached	H110W
	2	Wrenches 11mm	-
	1	Warranty card	-
	1	Manual	-

HEEL BRACKET INSTALLATION

Position the heel bracket in one of the three positions depending on the size of the user's feet. Secure heel bracket into the foot support plate with the small screws.

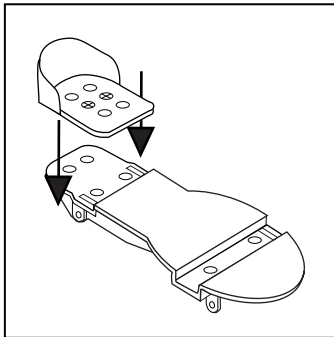

STILT ASSEMBLY

ARCH & TOE STRAP POSITIONS

The straps come preinstalled. Use the following instructions to adjust or replace the straps.

The leg band straps should be tightened by pulling away from the stilt. The toe and arch straps are tightened by pulling toward the inside of the stilt. Position the straps accordingly.

The arch strap can be worn in two different positions.

Option 1

1. To replace the arch strap, remove the side pole clamp bracket first.

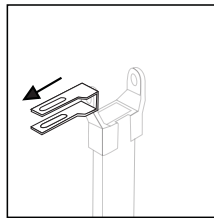
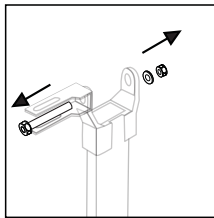

2. Thread the strap through the back of the foot plate.

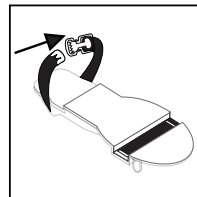
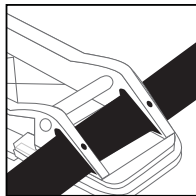

3. Secure the strap with the small screws and washers.

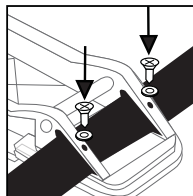

Note: 1½" wide arch strap (HP107FW) is available at www.stilts.com

STILT ASSEMBLY

Option 2

1. To wear the arch strap in option 2, remove the side pole clamp bracket first.

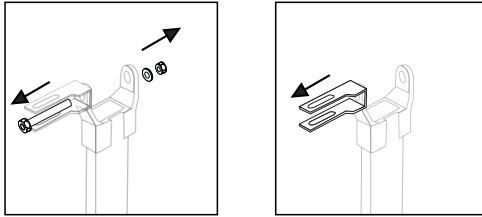

2. Thread the strap through foot plate.

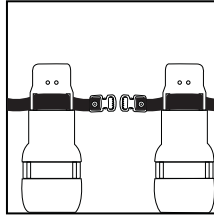

3. Secure the strap in place with the screws and washers.

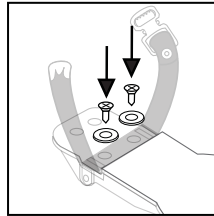

TOE STRAP INSTALLATION

Install the toe strap the same way as the arch strap (Option 2).

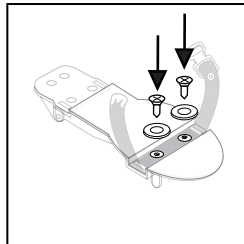

STILT ASSEMBLY

SINGLE SIDED POLE INSTALLATION

1. Insert lower strut tube (H123-XXXX) into the bracket on the main stilt body.

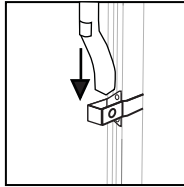

2. Secure with 1 1/2" bolt, two washers and nylon locknut (H124W).

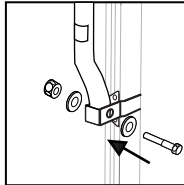

3. Line up the back of the side pole clamp (H12930AP) with the side pole clamp bracket (H1315) and secure with 1 3/4" bolt, two washers, and nylon locknut (H132W).

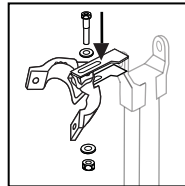
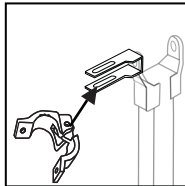

4. Wrap the sides of the clamp around the side pole and line up the key on the side pole with one of the three grooves on the clamp.

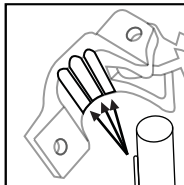

5. Secure with 1 1/2" bolt, two washers and nylon locknut (H124W).

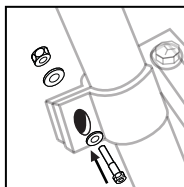

STILT ADJUSTMENTS

Sur-Pro stilts are designed to **maximize the user's comfort** when performing drywall and construction applications. The following components can all be adjusted:

STILT HEIGHT

1. To **adjust the height** of the stilts, **remove the wing bolts** (H142) from the stilts.
2. Slide vertically to desired height. Align the holes in the outer extrusion to those of the **inner leg extension**.
3. Reinstall the wing bolts at the desired height. **Hand-tighten** the wing bolts.

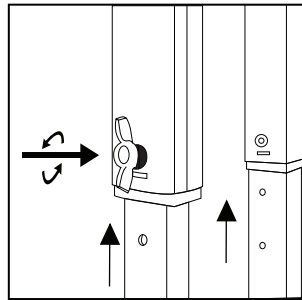
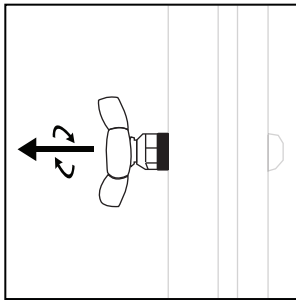

Note: The stilts have a plastic sleeve that prevents the leg extrusions from coming completely out of the stilt body. Forcing the leg extrusions out of the main stilt body will damage the plastic sleeves.

STILT ADJUSTMENTS

SIDE POLE ROTATION

Choose from three different side pole rotation angles. Select the angle that is most comfortable for the user.

1. Loosen the bolts securing the side pole clamp.
2. Line up the key on the side pole with one of the three grooves on the clamp.
3. Tighten the side bolt clamp.

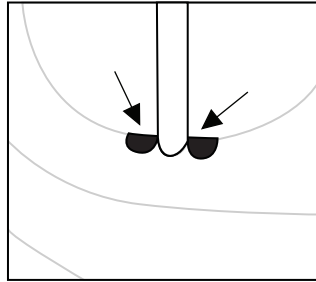
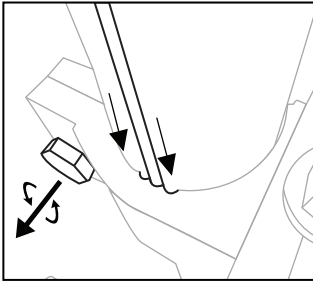

SPRING TENSION

To correct any tendency to lean **forwards**, tighten the upper spring adjuster to increase tension on the spring.

To correct a tendency to lean **backwards** when walking, tighten the lower spring adjuster to increase tension on the spring.

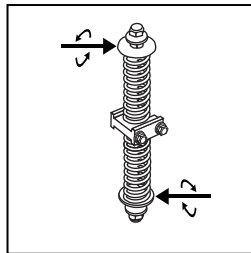

Note: Always check that all bolts and screws have been tightened after making adjustments and prior to every use.

LEARNING TO WALK

WARNING: Find a level, clean floor free of any tripping hazards to practice walking for the first time. Avoid openings such as doorways, floor vents, stairwells or windows that you can fall through. A messy jobsite is **NOT** the right place.

WALKING INSTRUCTIONS

- Prepare your stilts by installing the parts and making the necessary adjustments.
- Find a colleague to help you mount the stilts and secure the straps.
- Take slow, deliberate, and short steps. Pick the stilt up completely off the ground with each step. **Never** drag or shuffle the stilts on the ground. Keep your stilts apart when walking and do not let them touch.
- To turn, or change directions, walk in a wide “U” shape. Practice walking until you are comfortable in the stilts and feel able to walk unassisted.

WALKING SAFETY TIPS

- **DO NOT** take large or over-extended steps. If the springs are being completely compressed with each stride, your steps are too large. This puts more stress on the stilts and will reduce the lifespan of the stilt components.
- **NEVER** try walking backwards on the stilts.
- If you are required to step sideways on your stilts, make sure to practice the move with a spotter before attempting it on a jobsite. Look carefully before placing your stilt. Lift one stilt at a time while clear of the floor and plant your foot carefully before lifting the other stilt.

MAINTENANCE INSTRUCTIONS

CLEANING

Clean your stilts with water regularly. Dry the stilts and floor plates after cleaning. Dirty equipment may obscure excessive wear. Keep soles dry and free of lubricants and built-up debris to ensure a safe walking surface.

LUBRICATION

It is important to keep all pivot points or adjustment joints clean and lubricated. Use a silicone or graphite-based lubricant.

REPLACEMENT PARTS

It is important that all stilt parts are inspected before each use to see if any parts should be replaced. If any components have been worn out or dented, or if screws/washers/wing bolts have been lost, contact your dealer, visit www.stilts.com or call 1-888-443-8889 for genuine Sur-Pro replacement parts.

The Forest Group, Inc. is not responsible for any equipment failures if non-genuine Sur-Pro replacement parts are installed or if the stilt is dismantled and the components are not installed correctly.

REPLACEMENT PARTS DIAGRAM

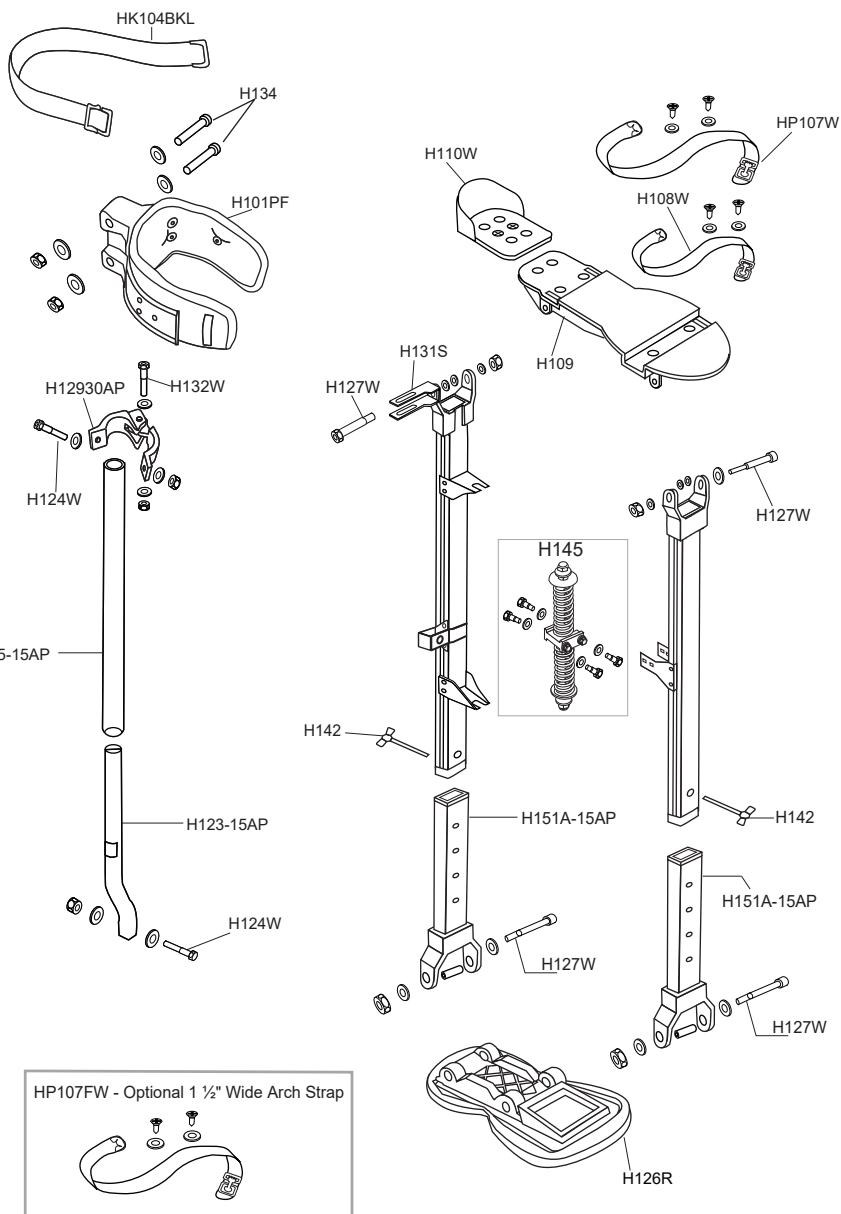

REPLACEMENT PARTS & KITS

Item	Description
H101PF	Replacement wraparound leg band for single sided Sur-Pro stilts
H104BK	Replacement leg band strap for single sided Sur-Pro stilts Dimensions: 1 ½" width, 10 ½" length
H105-15AP	Replacement leg pole upper strut for 15"-23" single sided Sur-Stilt stilts
H108W	Replacement adjustable toe strap with buckle for all Sur-Pro stilts with screws and washers Strap Dimensions: 1" width, 17" length
H109	Replacement nylon foot plate for all Sur-Pro Stilts
H110W	Replacement adjustable heel bracket aluminum with screws
H123-15AP	Replacement leg pole lower strut for 15"-23" single sided Sur-Stilt stilts
H124W	Replacement bolt with washers and locknut Dimensions: 1 ½" in length
H126R	Replacement rubber floor plate for all Sur-Pro stilts
H127W	Replacement bolt with washers and nut Dimensions: 3" in length
H12930AP	Replacement side pole clamp for single sided Sur-Pro stilts
H131S	Replacement metal clamp bracket for all Sur-Pro Stilts
H132W	Replacement bolt with washers and locknut Dimensions: 1 ¾" in length
H134W	Replacement bolt with washers and locknut Dimensions: 2" in length
H142	Replacement wing bolt for all Sur-Pro stilts
H145	Replacement spring for all Sur-Pro stilts
H151W-15AP	Replacement inner extension tube with upward and downward nylon sleeves
HP107FW	Replacement adjustable wide arch strap with buckle for all Sur-Pro stilts with screws and washers Strap Dimensions: 1 ½" width, 23" length
HP107W	Replacement adjustable arch strap with buckle, screws and washers for all Sur-Pro stilts Strap Dimensions: 1" width, 23" length
SS1001	Hardware kit for all Sur-Pro stilts <ul style="list-style-type: none"> • Replacement bolts with washers and nuts (count 8) Dimensions: 3" in length
SS1002BK	Strap kit for single sided Sur-Pro stilts <ul style="list-style-type: none"> • Replacement leg band straps (count 2) Dimensions: 1 ½" width, 10 ½" length • Replacement adjustable arch straps with buckles (count 2) Dimensions: 1" width, 23" length • Replacement adjustable toe straps with buckles (count 2) Dimensions: 1" width, 17" length • Replacement strap mounting washers (count 8) • Replacement strap mounting screws (count 8)

REPLACEMENT PARTS & KITS

Item	Description
SS1003R	Floor plate kit for all Sur-Pro stilts <ul style="list-style-type: none"> • Replacement rubber floor plate (count 2)
SS1004	Spring kit for all Sur-Pro stilts <ul style="list-style-type: none"> • Replacement spring (count 2)
SS1005P	Plastic leg band kit for single sided Sur-Pro stilts <ul style="list-style-type: none"> • Replacement plastic leg bands (count 2) • Replacement bolts with washers and nuts (count 4) <p style="margin-left: 20px;">Dimensions: 2" in length</p>
SS1005PF	Wraparound leg band kit for single sided Sur-Pro stilts <ul style="list-style-type: none"> • Replacement wraparound leg bands (count 2) • Replacement leg band straps (count 2) <p style="margin-left: 20px;">Dimensions: 1 ½" width, 10 ½" length</p> <ul style="list-style-type: none"> • Replacement bolts with washers and nut (count 2) <p style="margin-left: 20px;">Dimensions: 2" in length</p>
SS1006	Clamp and bracket kit for single sided Sur-Pro Stilts <ul style="list-style-type: none"> • Replacement side pole clamps (count 2) • Replacement metal clamp brackets (count 2) • Replacement bolts with washers and nuts (count 2)
SS1007	Plastic sleeve kit for all Sur-Pro stilts <ul style="list-style-type: none"> • Replacement upper plastic sleeves (count 4) • Replacement lower plastic sleeves (count 4)
SS1008	Wing bolt kit for all Sur-Pro stilts <ul style="list-style-type: none"> • Replacement wing bolts (count 4)
SS1009	Heel bracket kit for all Sur-Pro stilts <ul style="list-style-type: none"> • Replacement adjustable heel brackets with screws (count 2)

WARRANTY

Sur-Pro® One-Year Limited Warranty

- The Forest Group, Inc. offers a one-year limited warranty on the structural components of your Sur-Pro products against manufacturing defect from the date of purchase.
- Excluded are components subject to: normal wear, abuse, neglect, or improper assembly. Excluded parts include, but are not limited to, nylon bearings, sleeves, leg bands, soles, springs, and straps.
- The Forest Group, Inc. does not cover damage incurred by misuse of the product. In particular, Sur-Pro stilts are designed and intended for use in the construction and drywall industries and are not designed for use as a recreational or performance prop.
- The Forest Group, Inc. is only responsible for the repair or replacement of Sur-Pro products and parts.
- This warranty does not cover consequential damages, incidental damages, or damages to persons or property connected to the use of our products.
- The product owner is responsible for inbound shipping costs. Excluded from all warranties are inbound freight and postage or freight losses.
- The warranty is non-transferable and limited exclusively to the original purchaser.

Sur-Pro® Product Registration

We strongly encourage you to register your Sur-Pro products for quick access to warranty services and easy access to manuals, parts and documentation. To register, please:

- Visit www.stilts.com and fill out the online Product Registration form.
- Or
- Fill out all required fields on the enclosed registration card along with a copy of the owner's original invoice and return to:

The Forest Group, Inc.
P.O.Box 630388
Houston, TX 77263

Warranty Service

All warranty returns for repair must include a Return Merchandise Authorization (RMA) number. Unauthorized returns without RMA will not be accepted. To obtain the RMA number, please:

- Submit an online Warranty Service form on www.stilts.com and upload a copy of the owner's original proof of purchase.
- Or
- Call our Customer Service at 1-888-443-8889 and email/fax a copy of the owner's original proof of purchase.